

### Features

- Allows PC and UNIX workstation users to perform the following functions:
  - Program MAX® 9000, MAX 7000S, MAX 7000A, and MAX 3000A devices in-system via a standard RS-232 serial port
  - Configure FLEX® 10K, FLEX 8000, and FLEX 6000 devices in-circuit via a standard RS-232 serial port
- Downloads data from:
  - MAX+PLUS® II development software on PCs and UNIX workstations
  - A system prompt on PCs and UNIX workstations
- Provides two data download modes: passive serial (PS) and JTAG
- Programs/configures a single device or multiple devices in a chain
- Supports data transfer rates from 9,600 to 230,400 baud

### Functional Description

The BitBlaster™ serial download cable (ordering code: PL-BITBLASTER) is a hardware interface to a standard RS-232 port (called a “COM port” on PCs and either a “ttya port” or “ttyb port” on UNIX workstations). This cable channels configuration data to FLEX 10K, FLEX 8000, and FLEX 6000 devices, as well as programming data to MAX 9000 (including MAX 9000A), MAX 7000S, MAX 7000A, and MAX 3000A devices. Because design changes are downloaded directly to the device, prototyping is easy, and multiple design iterations can be accomplished in quick succession. See [Figure 1](#).

Figure 1. BitBlaster Serial Download Cable

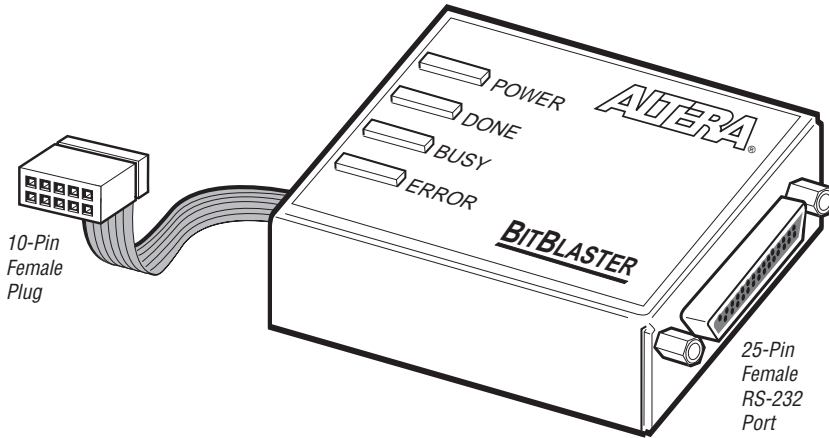

---

## Data Download Modes

The BitBlaster cable provides two data download modes:

- Passive serial (PS) mode—Used for configuring FLEX 10K, FLEX 8000, and FLEX 6000 devices
- JTAG mode—Industry-standard JTAG boundary-scan test (BST) circuitry (compliant with IEEE Std. 1149.1-1990) implemented for programming or configuring FLEX 10K, MAX 9000, MAX 7000S, MAX 7000A, and MAX 3000A devices.

## BitBlaster Connections

Data is downloaded from the computer's RS-232 port through the BitBlaster cable to the circuit board via the connections described in this section.



To configure/program 3.3-V devices (e.g., FLEX 10KA, FLEX 10KB, FLEX 10KE, MAX 7000A, and MAX 3000A devices) using the BitBlaster cable, connect the cable's VCC pin to a 5.0-V power supply and the device to a 3.3-V power supply. 3.3-V Altera devices have 5.0-V tolerant inputs, so the BitBlaster cable's 5.0-V output will not harm these 3.0-V devices. The pull-up resistors should be connected to the 5.0-V power supply.

*BitBlaster Female Port & Plug Connections*

The 25-pin female port connects to an RS-232 port with a standard serial cable. See [Table 1](#).

<b>Pin</b>	<b>Signal Name</b>	<b>Description</b>
2	tx	Transmit data
3	rx	Receive data
4	rts	Request to send
5	cts	Clear to send
6	dsr	Data set ready
7	GND	Signal ground
20	dtr	Data terminal ready

The 10-pin female plug connects to a 10-pin male header on the circuit board containing the target device(s). [Figure 2](#) shows the dimensions for the 10-pin female plug.

**Figure 2. BitBlaster 10-Pin Female Plug Dimensions**

Dimensions are shown in inches. The spacing between pin centers is 0.1 inch.

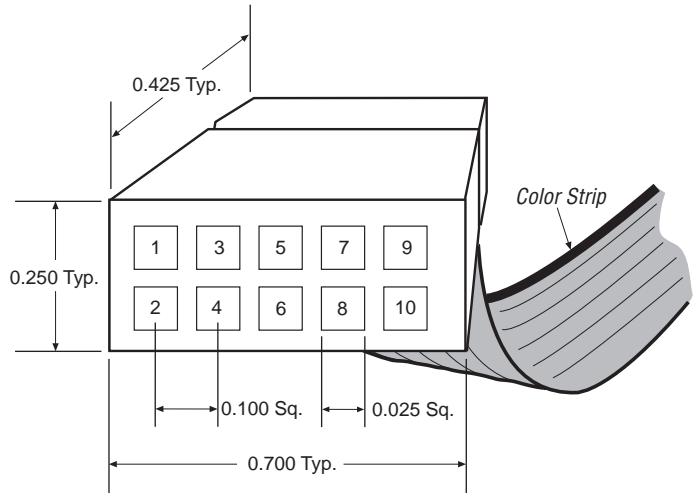

Table 2 identifies the 10-pin female plug's pin names for the corresponding download mode.

**Table 2. BitBlaster Female Plug's Pin Names & Download Modes**

Pin	JTAG Mode		PS Mode	
	Signal Name	Description	Signal Name	Description
1	TCK	Clock signal	DCLK	Clock signal
2	GND	Ground	GND	Ground
3	TDO	Data from device	CONF_DONE	Configuration done
4	VCC	Power supply	VCC	Power supply
5	TMS	JTAG state machine control	nCONFIG	Configuration control
6	NC	No connect	NC	No connect
7	NC	No connect	nSTATUS	Configuration status
8	NC	No connect	NC	No connect
9	TDI	Data to device	DATA0	Data to device
10	GND	Ground	GND	Ground

### Circuit Board Header Connection

The BitBlaster 10-pin female plug connects to a 10-pin male header on the circuit board. The 10-pin male header has two rows of five pins connecting the circuit board to the device's programming or configuration pins. The BitBlaster cable receives power and downloads data via the male header. [Figure 3](#) shows the dimensions of a typical 10-pin male header.

**Figure 3. 10-Pin Male Header Dimensions**

Dimensions are shown in inches.

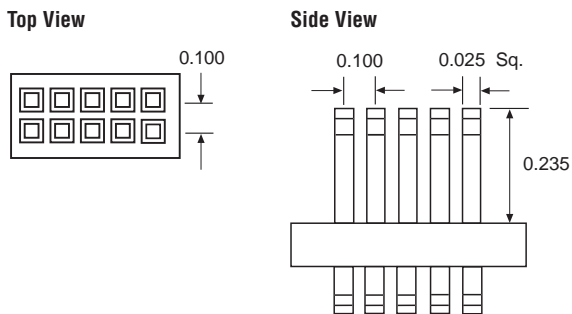

The circuit board must supply  $V_{CC}$  and ground to the BitBlaster cable.

### BitBlaster Status Lights



The BitBlaster status lights indicate the state of the device configuration or programming. See [Table 3](#).

Status Light	Description
POWER	Indicates a connection to the target system's power supply.
DONE	Indicates that device configuration or programming is complete.
BUSY	Indicates that device configuration or programming is in progress.
ERROR	Indicates error detection during configuration or programming.

## Data Transfer Rate Control & Operating Conditions

Three dipswitches on the side panel of the BitBlaster cable control the baud rate of the serial data. Table 4 shows the on/off dipswitch settings, which can be used to specify transfer rates ranging from 9,600 to 230,400 baud. The configuration time for an EPF81188A device, which uses 193,000 bits of configuration data, is also provided for reference.

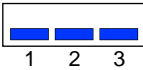
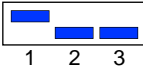
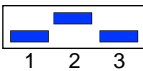
**Table 4. Dipswitch Settings** *Note (1)*

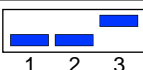
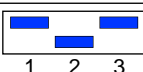
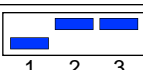
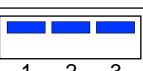
Baud Rate (BPS)	Dipswitch Positions	EPF81188A Configuration Time (Seconds)
230,400		1.5
115,200		3.0
76,800		4.5
57,600		5.5
38,400		8.5
19,200		17.0
14,400		22.0
9,600		33.0

**Note:**

- (1) The supported baud rates vary depending on the computer system. Refer to the computer system’s serial port hardware documentation to verify the available baud rates.



Search for “Hardware Setup command” in MAX+PLUS II Help for more information.

## Operating Conditions

The Tables 5 through 7 summarize the absolute maximum ratings, recommended operating conditions, and DC operating conditions for the BitBlaster cable.

**Table 5. BitBlaster Cable Absolute Maximum Ratings**

Symbol	Parameter	Conditions	Min	Max	Unit
$V_{CC}$	Supply voltage	With respect to ground	-2.0	7.0	V
$V_I$	DC input voltage	With respect to ground	-2.0	7.0	V

**Table 6. BitBlaster Cable Recommended Operating Conditions**

Symbol	Parameter	Conditions	Min	Max	Unit
$V_{CC}$	Supply voltage 5.0-V operation		4.75	5.25	V

**Table 7. BitBlaster Cable DC Operating Conditions**

Symbol	Parameter	Conditions	Min	Max	Unit
$V_{IH}$	High-level input voltage		2.0	$V_{CC} + 0.3$	V
$V_{IL}$	Low-level input voltage		-0.3	0.8	V
$V_{OH}$	5.0-V high-level TTL output voltage	$I_{OH} = -4 \text{ mA}$ , $V_{CC} = 4.75 \text{ V}$	2.4		V
$V_{OL}$	Low-level output voltage	$I_{OL} = 4 \text{ mA DC}$		0.45	V
$I_{CC}$	Operating current			100	mA

Figure 4 shows the typical 5.0-V output drive characteristics of the BitBlaster cable.

**Figure 4. BitBlaster Output Drive Characteristics**

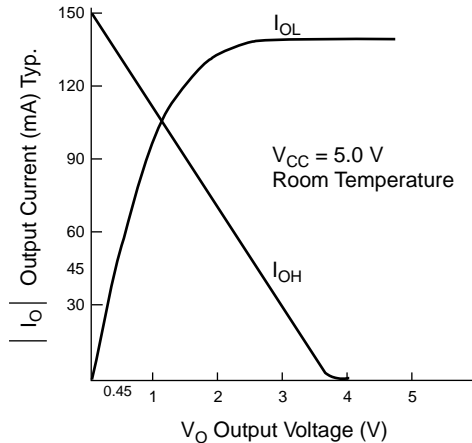

## Software Instructions

The MAX+PLUS II Programmer downloads configuration or programming data. For FLEX 10K, FLEX 8000, and FLEX 6000 devices, configuration data can also be downloaded by copying the SBF to the RS-232 port from the system prompt.

### Downloading Configuration or Programming Data from the MAX+PLUS II Programmer

To configure or program one or more devices with the BitBlaster cable and the MAX+PLUS II Programmer, follow these steps:

1. Compile a project. The MAX+PLUS II Compiler automatically generates an SOF for FLEX 10K, FLEX 8000, and FLEX 6000 device configuration, or a POF for MAX 9000, MAX 7000S, MAX 7000A, or MAX 3000A device programming.
2. Attach the BitBlaster cable to an RS-232 port on a PC or UNIX workstation and plug the 10-pin female header into the system containing the target device. Ensure that the POWER status light is on. The board must supply power to the BitBlaster cable.



3. If necessary, change the BitBlaster cable's baud rate using the dipswitches on its side panel. Dipswitch settings are listed in [Table 4 on page 6](#).
4. Open the MAX+PLUS II Programmer. Choose the **Hardware Setup** command (Options menu) to specify the BitBlaster cable and the appropriate RS-232 port. See "Changing the Hardware Setup" in MAX+PLUS II Help for more information.



When you first open the Programmer, the MAX+PLUS II software automatically loads the programming file for the current project (either a POF or SOF), or the first programming file for a multi-device project. To specify another programming file, choose **Select Programming File** (File menu) and specify the correct file type. For a FLEX 10K, FLEX 8000, or FLEX 6000 device, select an SOF; for a MAX 9000, MAX 7000S, MAX 7000A, or MAX 3000A device, select a POF.

5. For JTAG or FLEX-chain programming or configuration, perform the following:

- ✓ To program or configure devices in a JTAG chain (multi- or single-device chain), turn on **Multi-Device JTAG-Chain** (JTAG menu) and choose **Multi-Device JTAG Chain Setup** to set up the multi-device JTAG chain. See "Setting up Multi-Device JTAG Chains" in MAX+PLUS II Help for more information.



If the JTAG chain includes either FLEX or MAX devices exclusively, set up and create just one JTAG Chain File (.jcf). If the JTAG chain includes a mixture of FLEX and MAX devices, set up and create two separate JCFs.

- ✓ To configure multiple devices in a FLEX chain, turn on **Multi-Device FLEX Chain** (FLEX menu) and choose **Multi-Device FLEX Chain Setup** to setup the multi-device FLEX chain. See "Setting Up Multi-Device FLEX Chains" in MAX+PLUS II Help for more information.

6. Choose the **Program** or **Configure** button to program or configure the device(s). The BUSY status light on the BitBlaster cable turns on.

The BitBlaster cable downloads the data from the SOFs or POFs into the device(s). When configuration or programming is complete, the BUSY status light turns off, and the DONE status light turns on. After the DONE status light turns on, the BitBlaster can be disconnected.

## Downloading Configuration Data from a System Prompt (FLEX Devices Only)

To configure one or more FLEX 10K, FLEX 8000, or FLEX 6000 devices with the BitBlaster cable from a system prompt, follow these steps:

1. Compile the project(s) with the MAX+PLUS II Compiler. The Compiler automatically generates an SOF for device configuration.
2. Open the MAX+PLUS II Programmer or Compiler and choose the **Convert SRAM Object Files** command (File menu).
3. Specify the SOF name by selecting it in the *Files* box or by typing its name in the *File Name* box. Choose **Add** to add the file to the *Selected Files* box.
4. Specify the serial bitstream file format by selecting *.sbf (Sequential)* in the *File Format* drop-down list box. Choose **OK**.
5. Attach the BitBlaster cable to an RS-232 port on your PC or UNIX workstation, and plug the 10-pin female header into the prototype system that contains the target FLEX 10K, FLEX 8000, or FLEX 6000 device(s). Ensure that the POWER status light is on. The board must supply power to the BitBlaster cable.
6. If necessary, change the baud rate of the BitBlaster cable using the dipswitches on its side panel. Dipswitch settings are listed in [Table 4 on page 6](#).
7. Specify an RS-232 port and set its baud rate.

✓ On a PC, follow these steps:

- a. For 9,600 baud, type the following command at the system prompt:

```
mode com <serial port number>:9600,N,8,1 ←
```

- b. For baud rates greater than 9,600, type the following command at the command prompt:

```
slikmode/b<baud rate>/c<serial port number> ←
```



The **slikmode.exe** utility is available from the Altera FTP site (<ftp.altera.com>) as a self-extracting executable, **bitmode.exe**. For more detailed instructions on using the **slikmode.exe** utility, type `slikmode` ← at the system prompt.

- ✓ Because commands on UNIX workstations differ depending on the operating system, the following command is provided only as an example. On a UNIX workstation, type the following command from the system prompt:

```
stty <baud rate> </dev/<serial port number> ←
```

Check the workstation specifications to determine the maximum baud rate allowed by the hardware.

8. Configure the FLEX 10K, FLEX 8000, or FLEX 6000 device by copying the SBF to the serial port to which the BitBlaster cable is attached.

- ✓ On a PC, type the following command from the system prompt:

```
copy <filename>.sbf com<serial port number>: ←
```

- ✓ Because commands on UNIX workstations differ depending on the operating system, the following command is provided only as an example. On a UNIX workstation, type the following command from the system prompt:

```
cp <filename>.sbf /dev/<serial port number> ←
```

## Conclusion

Downloading configuration and programming data directly to the device via the BitBlaster cable allows designers to verify multiple design iterations in quick succession, thereby speeding the design cycle.

## References

For more information on configuration and in-system programmability (ISP), see the following sources:

- [Application Note 116 \(Configuring APEX 20K, FLEX 10K & FLEX 6000 Devices\)](#)
- [Application Note 33 \(Configuring FLEX 8000 Devices\)](#)
- [Application Note 38 \(Configuring Multiple FLEX 8000 Devices\)](#)
- [Application Note 39 \(IEEE 1149.1 \(JTAG\) Boundary-Scan Testing in Altera Devices\)](#)
- [Application Note 95 \(In-System Programmability in MAX Devices\)](#)

## Revision History

- Search for “Configuring a Single Device with the BitBlaster, ByteBlaster, or FLEX Download Cable,” “Setting Up Multi-Device JTAG Chains,” “Configuring Multiple Devices in a JTAG Chain with the BitBlaster or ByteBlaster,” and “Programming a Single Device with BitBlaster or ByteBlaster” in MAX+PLUS II Help.

The information contained in the *BitBlaster Serial Download Cable Data Sheet* version 4.02 supersedes information published in previous versions.

### Version 4.02 Changes

The *BitBlaster Serial Download Cable Data Sheet* version 4.02 contains the following changes:

- Information on MAX 3000A devices was added throughout the document.
- The “Passive Serial Mode” section was removed. This information is found in *Application Note 116 (Configuring APEX 20K, FLEX 10K & FLEX 6000 Devices)*.
- The “JTAG Mode” section was removed. This information is found in *Application Note 39 (IEEE 1149.1 (JTAG) Boundary-Scan Testing in Altera Devices)* and *Application Note 95 (In-System Programmability in MAX Devices)*.
- The “References” section was added, which provides sources for additional information on the BitBlaster download cable.
- Minor textual, illustration, and style changes were made to the data sheet.

### Version 4.01 Changes

The *BitBlaster Serial Download Cable Data Sheet* version 4.01 contains the following changes:

- References to MAX 9000A devices were added as needed.
- References to FLEX 10KB and FLEX 10KE devices were added to the configuring/programming 3.3-V devices paragraph in the “*BitBlaster Connections*” section.
- Minor textual, illustration, and style changes were made to the data sheet.

Copyright © 1995, 1996, 1997, 1998, 1999 Altera Corporation, 101 Innovation Drive, San Jose, CA 95134, USA, all rights reserved.

By accessing this information, you agree to be bound by the terms of Altera's Legal Notice.